



RB10

LITHIUM IRON PHOSPHATE BATTERY

ELECTRICAL SPECIFICATIONS

Nominal Voltage	12.8 V
Nominal Capacity	10 Ah
Capacity @ 25A	24 min
Energy	128 Wh
Resistance	≤90 mΩ @ 50% SOC
Efficiency	99%
Self Discharge	<3% per Month
Maximum Modules in Series	1

DISCHARGE SPECIFICATIONS

Maximum Continuous Discharge Current	10 A
Peak Discharge Current	20 A (7.5 s ±2.5 s)
BMS Discharge Current Cut-Off	30 A ±5 A (10 ±5 ms)
Recommended Low Voltage Disconnect	11 V
BMS Discharge Voltage Cut-Off	8 V (2.0 ±0.08 vpc) (100 ±50 ms)
Reconnect Voltage	10 V (2.5 ±0.1 vpc)
Short Circuit Protection	200-500 μs

TEMPERATURE SPECIFICATIONS

Discharge Temperature	-4 to 140 °F (-20 to 60 °C)
Charge Temperature	32 to 113 °F (0 to 45 °C)
Storage Temperature	23 to 95 °F (-5 to 35 °C)

DIMENSIONAL SPECIFICATIONS

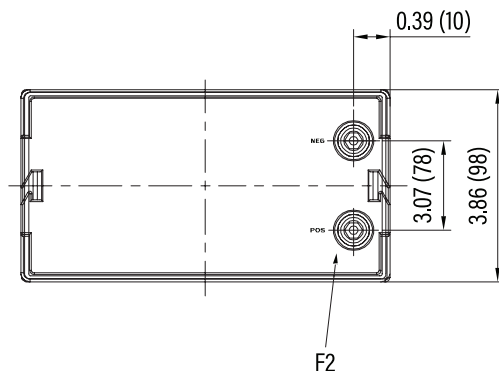

MECHANICAL SPECIFICATIONS

Dimensions (L x W x H)	5.9 x 3.9 x 4.0"
	151 x 98 x 101 mm
Weight	3.6 lbs (1.65 kg)
Terminal Type	F2
Case Material	ABS
Enclosure Protection	IP56
Cell Type	Cylindrical
Chemistry	LiFePO ₄

CHARGE SPECIFICATIONS

Recommended Charge Current	5 A
Maximum Charge Current	10 A
Recommended Charge Voltage	14.2 V - 14.6 V
BMS Charge Voltage Cut-Off	15.6 V (3.9 ±0.025 vpc) (1.0 ±0.5 s)
Reconnect Voltage	15.2 V (3.8 ±0.05 vpc)

COMPLIANCE SPECIFICATIONS

Certifications	CE (battery) UN38.3 (battery) UL1642 & IEC62133 (cells)
Shipping Classification	UN 3480, CLASS 9

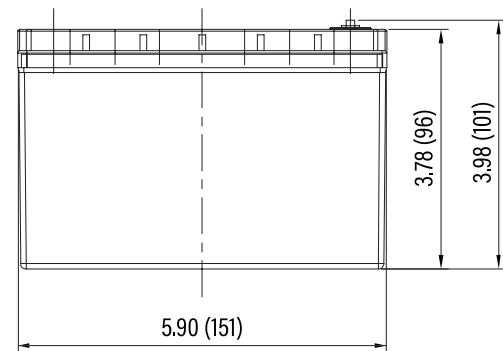



RB10

PERFORMANCE CHARACTERISTICS

DISCHARGE VOLTAGE CHARACTERISTICS at VARIOUS RATES
25°C (77°F)

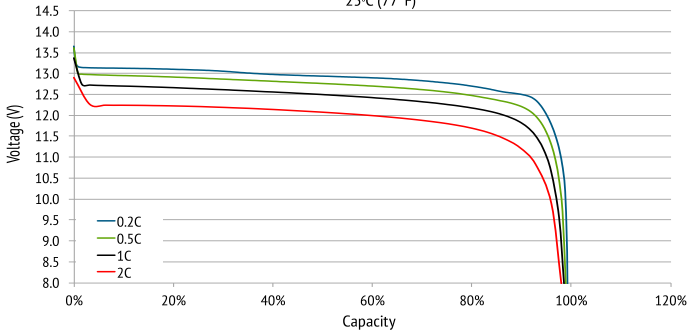

DISCHARGE VOLTAGE CHARACTERISTICS at VARIOUS TEMPERATURES
DISCHARGE 1C

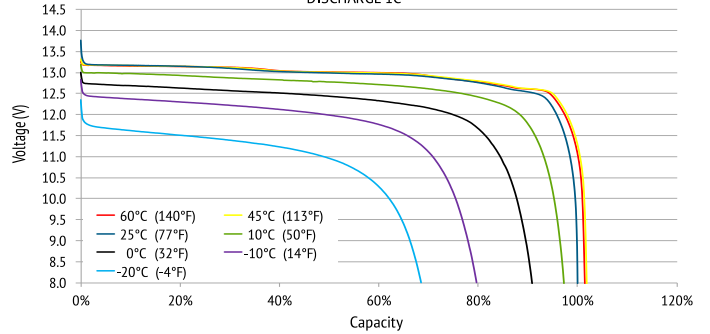

CHARGE VOLTAGE CHARACTERISTICS at VARIOUS TEMPERATURES
CHARGE 0.2C

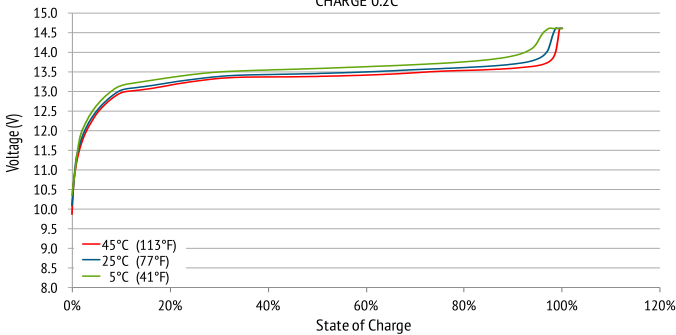

CHARGE VOLTAGE and STATE OF CHARGE (SOC)
CHARGE 0.2C @ 25°C (77°F)

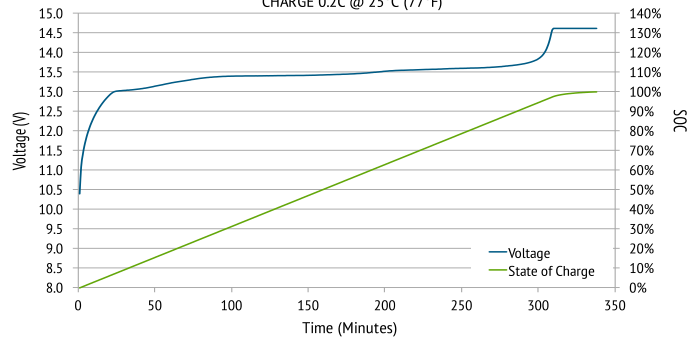

CYCLE LIFE vs. DEPTH OF DISCHARGE (DOD)
DISCHARGE 0.5C/CHARGE 0.5C @ 25°C (77°F)

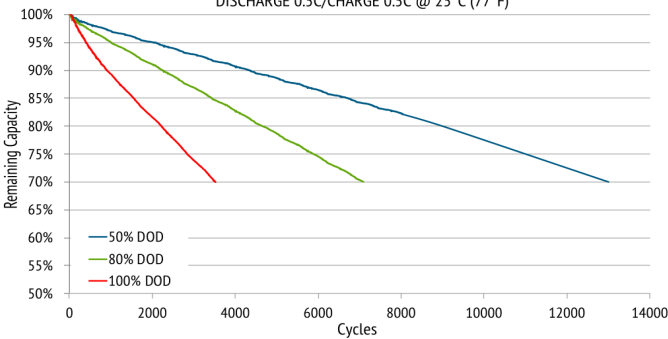

CAPACITY of RELiON LiFePO4 vs. LEAD ACID
at VARIOUS RATES OF DISCHARGE

